

Electrochemical cell design and development for mediated electrochemical oxidation-Ce(III)/Ce(IV) system

T. Raju*, C. Ahmed Basha

Central Electrochemical Research Institute, Karaikudi 630006, India

Received 19 May 2005; received in revised form 3 September 2005; accepted 13 September 2005

Abstract

Electrochemically produced and regenerated cerium(IV) ions are a well-known redox mediator and used as a redox catalyst for the oxidation of alkyl aromatics. Detailed studies have been carried out on the design and the development of electrochemical cells for the electrochemical preparation of cerium(IV) methanesulphonate. In Ce(III)/Ce(IV) redox mediator system, cerium(IV) ion has been generated from cerium(III) in both divided and undivided electrochemical cell in high current efficiency and yield.

© 2005 Elsevier B.V. All rights reserved.

Keywords: Electrochemical cell; Cerium(IV); Regeneration; Redox mediator; Undivided cell; Divided cell

1. Introduction

To develop an electrochemical reaction commercially, it is a great advantage to have some idea of electrochemical reactions occurring on the electrode [1]. During an electrochemical reaction the determination of electrochemical parameters which will influence the course of the reaction and results in high yield, conversion, selectivity and current efficiency will be achieved. In general, the electrochemical cells should be regarded as heterogeneous reactors [2] and this could be clearly demonstrated in the following reaction steps. The electrode reaction may proceed through all these steps or through some of these steps.

Mass transport step in an electrochemical reaction can be written as



'O' and 'R' are completely stable, and soluble in the medium of electrolysis containing an excess of electrolytic species which is electro inactive.



In design and development of an electrochemical cell, important fundamental characteristics of electrochemical reactors are their size, shape, flow regimes, magnitude of the current flow, types of electrodes, voltage drop across electrodes, nature of the electrolyte and other specific features [3–6].

In an electrochemical cell, the three modes of mass transfer in electrochemical systems are diffusion, migration and convection. In an electrochemical reaction, the electrode potential increase the current density. In the absence of side reactions it approaches a limiting value and the surface concentration of species 'O' decreases. Eventually the concentration of species 'O' becomes so small that an almost a constant current density is reached. This situation is such that as soon as the reactant 'O' reaches the surface it quickly reacts such that $C_0^s = O$ and mass transport is rate limiting. Thus, a limiting flux of the reactant is achieved, which is equal with the reaction rate and is given by

$$i_L = nFK_L C_0 \quad (5)$$

where i_L is the limiting current density; n the no. of electrons required for the reaction; F the Faradays constant; K_L the mass transfer coefficient and C_0 is the initial concentration of substrate.

For a mediated electrooxidation system, reaction steps are irreversible charge transfer followed by an irreversible chemical

* Corresponding author. Tel.: +91 4565227772; fax: +91 4565227713.
E-mail address: rajuoorganic@yahoo.co.in (T. Raju).

reaction.



where O is the oxidized compound; R the reduced compound; A the substrate and B is the oxidized products.

Mediated electrochemical oxidation (MEO) is a cyclic process involving electrochemical generation of a redox agent and use of that agent to effect a chemical reaction. For an oxidation reaction, the process can be represented schematically as follows:



where 'R_{ed}' represents the mediator in the reduced state. 'O_X' represents the mediator in the oxidized state. 'S' represents the reactant and 'P' represents the product. Ideally, an electrochemical redox reaction is reversible and a chemical reaction highly selective. It is advantages to carry out electrochemical and chemical reactions in separate vessels (so-called ex-cell method) so that each step can be optimised independently. Several processes using this scheme [6,7] as well as the chemistry of several mediators have been reviewed [8,9]. Engineering design considerations for mediated electro syntheses have been addressed by Picket [10,11].

A number of redox systems like Mn²⁺/Mn³⁺, Co²⁺/Co³⁺, Cr²⁺/Cr³⁺, Cr³⁺/Cr⁶⁺, Ti³⁺/Ti⁴⁺, Ce³⁺/Ce⁴⁺, V⁴⁺/V⁵⁺, Pd²⁺/Pd⁰, Sn⁴⁺/Sn²⁺, Ag²⁺/Ag⁺, Cu²⁺/Cu⁺ and Ru⁴⁺/Ru⁸⁺ in the form of liquid reagent or as an electrode system are available for carrying out the electrochemical regeneration and use the reagent for carrying out the chemical reaction in a separate chemical reactor.

1.1. Advantages of redox reagents in electrochemical synthesis

1. Wide ranges of redox reagents are available and the selection of the reagent depends upon the type and the suitability for organic synthesis.
2. The reaction can be made continues by suitably adjusting the electrochemical condition.
3. The redox reagent can be recycled and hence leaves zero effluent and discharge.
4. Inexpensive oxidizing agent (electricity).
5. High selectivity for a wide range of aldehydes and quinones.
6. Stable redox mediator under reaction conditions.
7. High current efficiency for an electrochemical reaction.
8. Electrochemical fouling eliminated by separating the chemical oxidation of organic compounds.
9. Easy availability of modern electrochemical reactors.

Methanesulphonic acid has been the medium of choice for the electrochemical oxidation of cerium(III) salts. In methanesulphonic medium cerium(III) methanesulphonate could be oxidized in the slurry form in both divided and undivided

cells. Recent observations of substantially higher solubility of cerium(III) methanesulphonate have led to some renewed interest in this process.

1.2. Design and development of electrochemical cells for Ce(III)/Ce(IV) system

In design and development of an electrochemical cell for electrochemical generation of cerium(III) methanesulphonate, important fundamental characteristics of electrochemical cells are their size, shape, flow regimes, magnitude of the current flow, types of electrodes and voltage drop across electrodes. Cerium(IV) ion has been generated from cerium(IV) in both divided and undivided electrochemical cells with high current efficiency and yield.

Electrochemical oxidation can occur either directly by electron transfers from the substrate to the electrode or vice versa or indirectly via mediator. Mediated electrooxidation is a cyclic process involving the electrochemical generation of a redox reagent and the use of the same to affect a chemical oxidation. At present, there is a considerable industrial interest in the mediated electrooxidation process for the synthesis of organic chemicals. As a result there has been much interest recently in the electrochemical recycling of these oxidants. Of these, Cr(IV) has lower selectivity, even though it is the most soluble and easy for regeneration. Mn(III) gives good selectivity but unsuitable at lower acid concentrations with poor solubility's of Mn(II) and Mn(III) at high acid concentrations. The powerful Co(III) is also unstable due to water oxidation. Cerium(IV) is generally preferred owing to its higher stability and excellent selectivity [7–12].

Commercialization of the use of cerium(IV) in HClO₄ is prevented due to explosive nature of perchloric acid in organic medium [13–15]. The use of cerium(III) sulphate in H₂SO₄ medium is limited by the low solubility. Methanesulphonic acid has been found to solubilise Ce(III)/Ce(IV) couple obviating the above difficulties resulting in a relatively high cerium(IV) concentration [16–20]. Regeneration with good current efficiency and selective organic oxidation with high conversion can be achieved with this system. This makes the cerium ions in mediated electrosynthesis for the commercial production of several carbonyl compounds [21–23].

Oxygen evolution is one of the most important technological reactions in electrochemistry, taking place on the anode of water electrolyzers, in metal electrowinning processes, in cathodic protection, in electroorganic reduction and so on. Oxygen evolution is very often the more difficult of the two electrolytic reactions in an electrochemical cell, so that the economy of the entire process is governed by that of the anodic reaction. For these reasons, the search for new or improved materials with lower over potential for oxygen evolution is ongoing [24].

Oxygen evolution is a critical reaction since it creates very aggressive conditions for the electrode material of anodes. This is particularly true in an acidic solution, for which the severe conditions are enhanced in applications involving proton conductor solid polymer electrolytes. The latter environment is resisted only by thermal oxides of precious transition metals [25], which belong to the wide class of dimensionally stable anodes (DSA).

Only RuO₂ and IrO₂ have been thus far extensively investigated as anodes for O₂ evolution in an acidic solution. While RuO₂ is more active than IrO₂ [26,27], the latter is much more corrosion-resistant than the former. In particular, IrO₂ + Ta₂O₅ mixed oxides are indicated as the stablest anodes for oxygen evolution in a strongly acidic environment, such as water electrolysis with solid polymer electrolyte (SPE) or copper electrowinning [28–31].

The mediated electrooxidation process was found to be even more advantageous with the use of cerium(IV) salt in methanesulphonic acid medium. A number of poly nuclear aromatic hydrocarbons can be oxidized to their corresponding quinones in this medium. Vijayabarathi et al. [33–35] have made a comparative study of the redox behaviour of Ce(III)/Ce(IV) in nitric acid, sulphuric acid, perchloric acid and methanesulphonic acid medium. Recently, Fang et al. and co-workers [36–38] have reported further improvements in the overall two-stage oxidation process. The overall reviews on recent developments in this field are also available. In the present studies, it was felt desirable to investigate the process optimisation, kinetic study and various types of cells for the electrochemical generation of cerium(IV) methanesulphonate in aqueous methanesulphonic acid medium.

In this paper, the design and development of electrochemical cells for Ce(III)/Ce(IV) redox reaction has been evaluated in methanesulphonic acid medium in high current efficiency, yield, space–time yield and low energy consumption. Various types of cells were employed and studied for the generation of cerium(IV) methanesulphonate. The Ce(III)/Ce(IV) redox system has attracted attention in electroorganic synthesis for indirect oxidation of aromatic and alkyl aromatic compounds.

2. Experimental

Electrochemical oxidation of cerium(IV) methanesulphonate was conducted in divided cells. The following three types of cells were employed for carrying out electrooxidation reaction

- (1) batch cell;
- (2) batch cell with re-circulation;
- (3) electro MP flow cell.

and in an undivided cell, batch cell has been employed for studies.

The electrolysis was carried out under constant current condition. After the electrolysis, the anolyte solution of cerium(IV) ions were quantitatively analysed by titration with ferrous ammonium sulphate using ferroin as an indicator [32]. Current efficiency, yield and space–time yield were determined in each case.

2.1. Divided electrochemical cells for the generation of cerium(IV) methanesulphonate

Three different types of divided cells were used for the electrooxidation of cerium(III) methanesulphonate solution. Electrochemical parameters, such as current density, concentration,

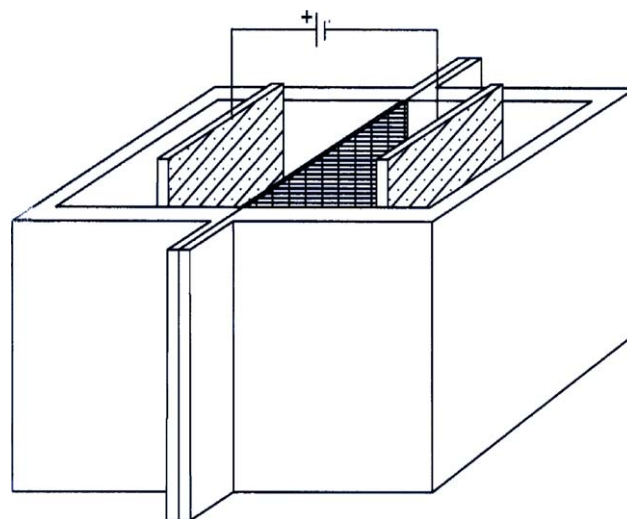

Fig. 1. Schematic diagram of electrochemical batch cell. Anode working area, 40 cm² (8 cm × 5 cm); cathode working area, 40 cm² (8 cm × 5 cm); anolyte compartment size, 4 cm × 9 cm × 7 cm (*L* × *B* × *H*); catholyte compartment size, 4 cm × 9 cm × 7 cm (*L* × *B* × *H*); anolyte volume, 175 ml and catholyte volume, 175 ml.

temperature and stirring rate are studied using the above cells and effects on these parameters are discussed in Section 3.

2.1.1. Batch cell

A rectangular PVC tank cell (Fig. 1) with Nafion membrane was used as a diaphragm material for the oxidation system. Anode and cathode were DSA-O₂ (mesh type) and stainless steel, respectively. In both the anolyte and catholyte chamber a temperature of 50 °C was maintained throughout the reaction. Electrolysis was carried out under constant current condition. During the electrolysis samples were analysed with respect to time for cerium(IV) ion quantitatively and based on the cerium(IV) ion formation the current efficiency and the yield are calculated.

2.1.1.1. Experimental conditions for batch cell

| | |
|------------------------|---|
| Anode: | DSA-O ₂ (working area = 40 cm ²) |
| Cathode: | Stainless steel (area = 40 cm ²) |
| Anolyte: | Cerium(III) methanesulphonate (46 mmoles, 175 ml) |
| Catholyte: | Methanesulphonic acid (175 ml) |
| Anolyte compartment: | 4 cm × 9 cm × 7 cm (<i>L</i> × <i>B</i> × <i>H</i>) |
| Catholyte compartment: | 4 cm × 9 cm × 7 cm (<i>L</i> × <i>B</i> × <i>H</i>) |
| Cell capacity: | 500 ml |
| Current density: | 50 mA/cm ² |
| Temperature: | 50 °C |
| Stirring rate: | 150 rpm |
| Diaphragm: | Nafion 324 series membrane. |

2.1.2. Batch cell with re-circulation

An electrooxidation was carried out in a batch cell (Fig. 2) for the electrochemical generation of cerium(IV) methanesulphonate with re-circulation. The anolyte solution of cerium(III) methanesulphonate was circulated through a pump to the above cell and a provision was made in the cell. During the electrolysis samples

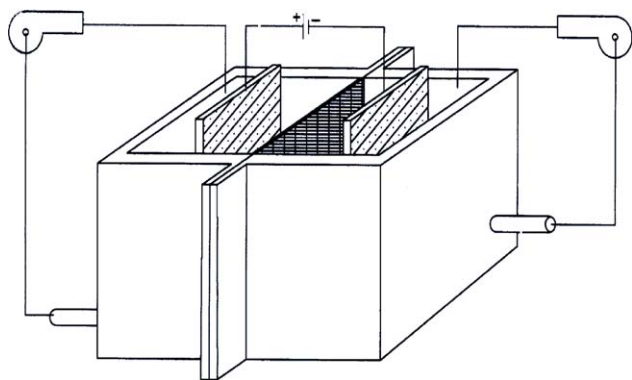

Fig. 2. Schematic diagram of batch re-circulation cell. Anode working area, 40 cm^2 ($8\text{ cm} \times 5\text{ cm}$); cathode working area, 40 cm^2 ($8\text{ cm} \times 5\text{ cm}$); anolyte compartment size, $4\text{ cm} \times 9\text{ cm} \times 7\text{ cm}$ ($L \times B \times H$); catholyte compartment size, $4\text{ cm} \times 9\text{ cm} \times 7\text{ cm}$ ($L \times B \times H$); anolyte volume, 175 ml and catholyte volume, 175 ml.

were taken with respect to time and analysed for cerium(IV) ion formation by titration using ferrous ammonium sulphate.

2.1.2.1. Experimental conditions for batch with re-circulation cell

| | |
|------------------------|---|
| Anode: | DSA-O ₂ (working area = 40 cm^2) |
| Cathode: | Stainless steel (working area = 40 cm^2) |
| Anolyte: | Cerium(III) methanesulphonate (46 mmoles, 175 ml) |
| Catholyte: | Methanesulphonic acid (175 ml) |
| Anolyte compartment: | $4\text{ cm} \times 9\text{ cm} \times 7\text{ cm}$ ($L \times B \times H$) |
| Catholyte compartment: | $4\text{ cm} \times 9\text{ cm} \times 7\text{ cm}$ ($L \times B \times H$) |
| Cell capacity: | 500 ml |
| Current density: | 5 A/dm^2 |
| Temperature: | 50°C |
| Diaphragm: | Nafion 324 series membrane |
| Flow rate: | 1.5 LPM |

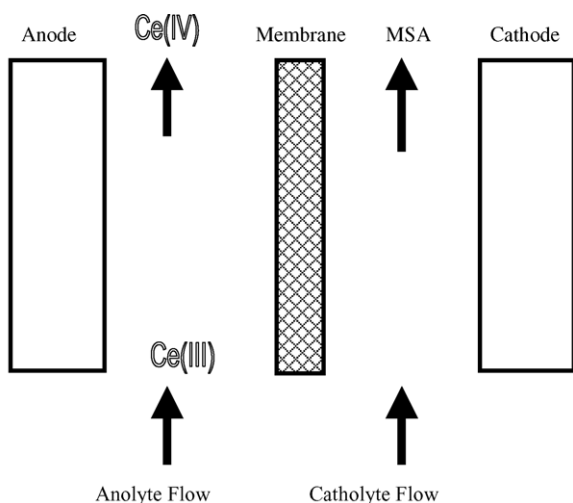

Fig. 3. Schematic diagram of electro MP cell. Anode working area, 100 cm^2 ($10\text{ cm} \times 10\text{ cm}$); cathode working area, 100 cm^2 ($10\text{ cm} \times 10\text{ cm}$); anolyte compartment, $0.6\text{ cm} \times 13\text{ cm} \times 18\text{ cm}$ ($L \times B \times H$); catholyte compartment, $0.6\text{ cm} \times 13\text{ cm} \times 18\text{ cm}$ ($L \times B \times H$); anolyte holding volume, 200 ml and catholyte holding volume, 200 ml.

2.1.3. Flow cell electro MP cell

This is a plate and frame type cell (Fig. 3) and it is commercially available cell. The merit of this cell is described by Spotnitz et al. [15] was used for the electrochemical oxidation of cerium(IV) methanesulphonate to cerium(III) methanesulphonate. Electrodes used were DSA-O₂ and stainless steel. In this cell, conditions of electrolysis were optimised with respect to current density, temperature and concentration of cerium(III) ion.

2.1.3.1. Experimental conditions for electro MP flow cell

| | |
|------------------------|---|
| Anode: | DSA-O ₂ (area = 100 cm^2) |
| Cathode: | Stainless steel (area = 100 cm^2) |
| Anolyte: | Cerium(III) methanesulphonate (46 mmoles, 500 ml) |
| Anolyte compartment: | $0.6\text{ cm} \times 13\text{ cm} \times 18\text{ cm}$ ($L \times B \times H$) |
| Anolyte compartment: | 200 ml |
| Catholyte: | Methanesulphonic acid (500 ml) |
| Catholyte compartment: | $0.6\text{ cm} \times 13\text{ cm} \times 18\text{ cm}$ ($L \times B \times H$) |
| Cell capacity: | 500 ml |
| Current density: | 50 mA/cm^2 |
| Temperature: | 50°C |
| Diaphragm: | Nafion 324 series membrane |
| Flow rate: | 1.5 LPM |

2.2. Undivided electrochemical cells for the generation of cerium(IV) methanesulphonate

Electrochemical preparation of cerium(IV) methanesulphonate from cerium(III) methanesulphonate using aqueous methanesulphonic acid medium was carried out in an undivided electrochemical cell (Fig. 4). Process optimisation studies on current efficiency, yield and space-time yield were carried out using the above cell.

Experiments were carried out in an undivided batch cell (500 ml capacity). Cerium(III) oxidation was carried out with DSA-O₂ anode (48 cm^2) and stainless steel cathode (6 cm^2) with an inter-electrode gap of 1–6 cm. In electrolyte chamber a temperature of 50°C was maintained throughout the reaction. The electrolysis was carried out under constant current electrolysis condition. After the electrolysis, the solution of cerium(IV) ions was quantitatively analysed by titration with ferrous ammonium sulphate using ferroin indicator [32]. Following studies were

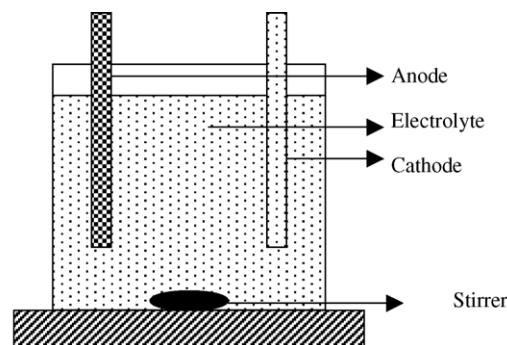

Fig. 4. Schematic diagram of undivided batch cell.

conducted using the undivided cell and the results are discussed in Section 3.

- i. Studies on effect of differential cathode area on current efficiency.
- ii. Studies on effect of total cerium concentration on current efficiency.
- iii. Studies on effect of methanesulphonic acid concentration on current efficiency.

2.2.1. Experimental conditions for undivided batch cell

| | |
|------------------------|---|
| Anode: | DSA-O ₂ (working area = 48 cm ²) |
| Cathode: | Stainless steel (working area = 8 cm ²) |
| Electrolyte: | Cerium(III) methanesulphonate (46 mmoles) |
| Cell working volume: | 300 ml |
| Cell capacity: | 500 ml |
| Cell size (L × B × H): | 8 cm × 9 cm × 7 cm |
| Current density: | 5 mA/cm ² |
| Temperature: | 50 °C |
| Stirring rate: | 150 rpm |

3. Results and discussion

The following reactions take place in the cell for Ce(IV)/Ce(III) system.

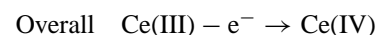
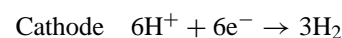
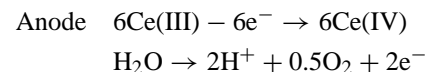

3.1. Electrochemical preparation of cerium(IV) methanesulphonate

The current efficiency, yield, space–time yield and energy consumption were calculated for the electrochemical preparation of cerium(IV) methanesulphonate in both divided and undivided cells and using the following equations the quantities were determined.

3.1.1. Amount of cerium(VI) methanesulphonate generated

The amount of cerium(IV) methanesulphonate generated or synthesised theoretically is dependent on the quantity of electricity of passed through the electrolytic solution. A simple relationship between current density and the amount of cerium(IV) methanesulphonate generated can be derived from Faraday's law

$$m_t = \frac{MIt}{zF} \quad (10)$$

m_t is the quantity of reactant; M the molecular weight of reactant; I the rate of current passed; t the time of electrolysis; z the no. of electrons for oxidation and F is the Faraday's constant.

3.1.2. Current efficiency

Current efficiency is calculated basis of the ratio of amount of cerium(IV) methanesulphonate generated to the theoretical amount of cerium(IV) methanesulphonate by Faradays law. The amount of cerium(IV) methanesulphonate generated is dependent on the quantity of charge passed through the electrolytic solution. For all the cells employed for the electrooxidation process the current efficiency is calculated based on the following equation.

$$\text{Current efficiency } (\phi) = \frac{m_e}{m_t} \times 100 \quad (11)$$

m_e is the amount of product obtained experimentally and m_t is the amount of product by Faraday's law ($m_t = MIt/zF$).

3.1.3. Yield

Yield of cerium(IV) methanesulphonate is calculated on the basis of the ratio of the amount of cerium(IV) methanesulphonate generated to the theoretical amount of cerium(IV) methanesulphonate expected on passage of total current. For divided and undivided cells employed for the electrooxidation process the current efficiency is determined using the following equation. For mediated electrooxidation process the yield is equal to the current efficiency of the process due to only 100% theoretical current passed for the electrooxidation of cerium(IV) methanesulphonate.

$$\text{Yield} = \frac{\text{Amount of cerium(IV) methanesulphonate generated}}{\text{Theoretical amount cerium(IV) methanesulphonate}}$$

3.1.4. Space–time yield (STY)

The space–time yield for electrochemical cells employed for the generation of cerium(IV) methanesulphonate is calculated on the basis of concentration of cerium(IV) methanesulphonate to the time of electrolysis. The amount of cerium(IV) methanesulphonate generated per unit volume of the cell per unit time, for divided and undivided cells, can be determined using the following equation.

$$g_t = \frac{C_0 - C_t}{t} \quad (\text{for batch cell}) \quad (12)$$

$$g_t = \frac{U(C_0 - C_t)}{L} \quad (\text{for flow cell}) \quad (13)$$

3.1.5. Energy consumption

For any electrochemical process the energy consumption is an important factor for the process development. The energy consumption for the electrochemical generation of cerium(IV) methanesulphonate is calculated using the following equation. Energy consumption mainly depends on the cell voltage of process.

$$\text{EC} = \frac{VI t}{m} \quad (14)$$

V is the cell voltage (V); I the current passed (A); t the time of electrolysis (h); m the kg of product (kg) and EC is the energy consumption (Wh/g or kW/(h kg)).

Table 1
Current efficiency and space–time yield in divided cells

| S. no. | Type of cell | Inter-electrode gap (mm) | Cell voltage (V) | Current efficiency (%) | Space–time yield (kg/(m ³ h)) |
|--------|--------------------------------|--------------------------|------------------|------------------------|--|
| 1 | Batch cell | 8 | 3.8 | 97 | 409 |
| 2 | Batch cell with re-circulation | 8 | 3.8 | 92 | 389 |
| 3 | Flow cell electro MP cell | 6 | 3.5 | 93 | 397 |

Anode, DSA-O₂; cathode, stainless steel; anolyte, cerium(III) methanesulphonate; catholyte, methanesulphonic acid; stirring rate, 150 rpm; type of cell, divided batch cell; diaphragm, Nafion 324 series membrane; temperature, 50 °C.

3.2. Studies on divided electrochemical cells for the generation of cerium(IV) methanesulphonate

Cerium(IV) methanesulphonate is generated in divided cells at optimised process conditions. Table 1 shows the results of electrooxidation of cerium(III) methanesulphonate using three different types of divided electrochemical cells at optimised electrochemical process parameters like current density = 50 mA/cm², temperature = 50 °C, cerium(III) concentration = 0.8 M and stirring speed of 150 rpm. During the selection of anode studies, dimensionally stable anodes oxygen evolution electrode gives high current efficiency. In this cell, the anolyte was stirred by means of a mechanical glass stirrer. The high solubility of the cerium(IV) ion in 2–3 M methanesulphonic acid enhances the generation of cerium(IV) ion concentration with high current efficiency (97%) at a current density of 50 mA/cm².

Experiments were carried out in batch/batch with re-circulation/flow cell for electrooxidation of cerium(III) methanesulphonate to cerium(IV) methanesulphonate and results are discussed in the following sections.

3.2.1. Batch cell

Simple batch cell (Fig. 1) is charged with reactants, stirred well and then left for a period for the reaction to occur to some predetermined extent. The resulting solution was then discharged from the cell and worked up to isolate the product. Concentration of reactants and products will change smoothly with time (in a way dependent on the reaction kinetics) but the composition is uniform throughout the reactor volume and the residence time is well defined, i.e. the same as the reaction time.

In a batch cell, a constant volume of electrolyte 'V_R' which is well mixed with in the reactor at all times. Concentration of the reactant will decrease from an initial concentration of 'C₀' to a value 'C_t' at time 't'. Effective stirring makes the concentration spatially uniform and the reaction show first order kinetics with respect to the reactant.

The fractional conversion in a simple batch reactor may be expressed as

$$X_A = \frac{1 - C_t}{C_0} = 1 - \exp \left[-k_L \left(\frac{A}{V_R} \right) t \right] \quad (15)$$

C₀ is the initial of concentration of cerium(III); C_t the final concentration of cerium(III) with time interval; A the area of the electrode; V_R the reactor volume and t is the time of electrolysis.

By its very nature, a batch cell operates in an un-steady state, the reactant and product concentrations being time dependent.

Above studies were carried in a tank type fabricated batch cell (Fig. 1). In that cell, the anolyte was stirred by means of mechanical glass stirrer. Time–current efficiency relationship for the generation of cerium(IV) ions using this cell is shown in Table 2. At optimised conditions current efficiency of 97% is achieved. This design is simple and easy to scale up further.

3.2.2. Batch cell with re-circulation

Batch re-circulation (Fig. 2) is a particularly flexible and convenient mode of operation. The provision of a reservoir external to the stirred tank reactor may serve several useful purposes. In addition to increasing of the electrolyte inventory it may help to correct pH, stabilize temperature, facilitate sampling act as a gas dis-engagement vessel or a solid liquid separator and provide a convenient, well-stirred zone for the reactant preparation and mixing prior to electrolysis.

The fractional conversion may be expressed

$$C_{Af} = C_{AO} \exp \left\{ - \left(\frac{t_f q}{V_{Res}} \right) \left[\frac{k_L A / q}{1 + k_L A / q} \right] \right\} \quad (16)$$

The system as a whole approximates to continuously stirred tank behaviour if the reservoir volume is much higher than that of the reactor and the reservoir residence time is high. Both the inlet and outlet reactor concentrations are time-dependent.

Studies were carried out to improve the mass transfer rate, by circulating the anolyte solution in a batch cell with above said conditions. The cerium(IV) ion concentration was monitored with time at different intervals and it is shown in Table 2. In this cell, the current efficiency of 92% was achieved.

Table 2
Time–current efficiency relationship for the generation of cerium(IV) using divided batch/batch with re-circulation/flow cell

| S. no. | Time (min) | Current efficiency (%) | | |
|--------|------------|------------------------|--------------------------------|---------------------------|
| | | Batch cell | Batch cell with re-circulation | Flow cell electro MP cell |
| 1 | 0 | 0 | 0 | 0 |
| 2 | 30 | 88 | 92 | 93 |
| 3 | 60 | 84 | 90 | 89 |
| 4 | 100 | 81 | 84 | 91 |
| 5 | 140 | 80 | 87 | 94 |
| 6 | 170 | 97 | 92 | 93 |

Anode, DSA-O₂; cathode, stainless steel; anolyte, cerium(III) methanesulphonate; catholyte, methanesulphonic acid; stirring rate, 150 rpm; type of cell, divided batch cell; diaphragm, Nafion 324 series membrane; temperature, 50 °C.

Table 3
Kinetic study on batch/batch re-circulation/electro MP cells

| S. no. | Type of cell | Anode material | Mass transfer k_L (cm/s) |
|--------|---------------------------|---------------------------------|----------------------------|
| 1 | Electro MP cell | DSA-O ₂ (mesh type) | 4.0×10^{-4} |
| 2 | Electro MP cell | DSA-O ₂ (plate type) | 6.0×10^{-4} |
| 3 | Batch cell | DSA-O ₂ (mesh type) | 8.0×10^{-3} |
| 4 | Batch cell | DSA-O ₂ (plate type) | 7.0×10^{-3} |
| 5 | Batch re-circulation cell | DSA-O ₂ (mesh type) | 8.3×10^{-3} |
| 6 | Batch re-circulation cell | DSA-O ₂ (plate type) | 7.8×10^{-3} |

Anode, DSA-O₂; cathode, stainless steel; anolyte, cerium(III) methanesulphonate; catholyte, methanesulphonic acid; stirring rate, 150 rpm; type of cell, divided batch cell; diaphragm, Nafion 324 series membrane; temperature, 50 °C.

3.2.3. Flow cell electro MP cell

The flow cells (Fig. 3) are based on the plug flow reactor model with parallel-plate electrode configuration and the electrodes may be horizontal or vertical. The flow cell is usually constructed with vertical electrodes in a plate-and-frame arrangement and mounted on a fitter press. Electrodes, electrolyte chambers, insulating plates to separate cells were used. Membrane or separators are constructed individually and mounted with suitable gasket materials between each component.

In plate-and-frame cells it is normal to reduce the inter-electrode gap to 0.6 cm and the electrolyte flow rates are often high. The electrolyte entry ports must be designed to give a uniform distribution of electrolyte into the cell and an adequate linear velocity. The flow within the cell can be made more turbulent. Most common method of turbulence promotion is the use of an electrode which each has a definite texture and/or insulating plastic meshes next to the electrode. The design equation for a flow type cells on batch operation with re-circulation through a CSTR reactor is by Eq. (16).

Electrochemical oxidation of cerium(III) methanesulphonate to cerium(IV) methanesulphonate was studied extensively in the plate and frame type cell. A typical time–current efficiency relationship for this cell and current efficiency is shown in Table 2. A high current efficiency of 93% is achieved using the electro MP cell at optimised conditions.

Apparent mass transfer coefficient (k_L) was determined by estimating the cerium(IV) ion concentration–time behaviour for the above three cells and results are presented in Table 3. These mass transfer coefficients can be used to estimate the minimum reactor area required for high current efficiency and conversion.

Table 4

Results of the electrochemical oxidation of Ce(III) to Ce(IV) in an undivided cell showing the influence of different ratio of cathode to anode area

| S. no. | Area of cathode to anode | Cathode area (cm ²) | Anode area (cm ²) | Anode current density (mA/cm ²) | Cathode current density (mA/cm ²) | Current efficiency (%) |
|--------|--------------------------|---------------------------------|-------------------------------|---|---|------------------------|
| 1 | 1:1 | 48 | 48 | 10 | 10 | 59 |
| 2 | 1:2 | 24 | 48 | 10 | 20 | 71 |
| 3 | 1:4 | 12 | 48 | 10 | 40 | 79 |
| 4 | 1:8 | 6 | 48 | 10 | 80 | 91 |
| 5 | 1:12 | 4 | 48 | 10 | 120 | 85 |
| 6 | 1:16 | 3 | 48 | 10 | 160 | 88 |

Anode, DSA-O₂; cathode, stainless steel; electrolyte, cerium(III) methanesulphonate; stirring rate, 150 rpm; total cell capacity, 500 ml; type of cell, divided batch cell; diaphragm, Nafion 324 series membrane; temperature, 50 °C.

3.3. Undivided electrochemical cells for the generation of cerium(IV) methanesulphonate

For an electrochemical cell the two important quantities are current efficiency and space–time yield. In the present work, the electrochemical preparation of cerium(IV) methanesulphonate from cerium(III) methanesulphonate using aqueous methanesulphonic acid medium in undivided electrochemical cell (Fig. 4) was carried out. Some electrode ratio studies on current efficiency and space–time yield using the above cell were also carried out.

In the process of electrochemical generation of cerium(IV) methanesulphonate in an undivided cell, competing reactions occur at both the anode and the cathode. At the anode the primary reaction is the oxidation of cerium(III) methanesulphonate to cerium(IV) methanesulphonate. This reaction is limited by mass transfer at increased potentials. The secondary reaction is the oxygen evolution reaction, which is kinetically controlled.

The hydrogen evolution reaction is kinetically controlled whereas the cerium(IV) reduction is mass transfer controlled. Consequently, the cathode current efficiency for hydrogen is promoted by high current densities. The use of an differential area cell is aimed at optimising the cell efficiency for cerium(IV) by producing relatively high cathode current densities together with low anode current densities in an undivided cell.

3.3.1. Study on effect of differential cathode area on current efficiency in undivided cell

Ce(III)/Ce(IV) system was carried out using different cathode areas varying from 1:1 to 1:16. The observed results are given in Table 4. From the table it is observed that at cathode to anode area ratio of 1:8, the maximum current efficiency of 91% is obtained. During electrolysis the temperature of the electrolyte rises as the cathode current density was high. Hence, the temperature of the electrolyte is maintained at 50 °C. Some experiments were carried out with an inter-electrode distance of 1–6 cm. All experiments gave same current efficiency. The oxidation of cerium(III) was also carried out at different anode current densities ranging from 5 to 30 mA/cm². At 10 mA/cm² the best current efficiency was obtained. Results are given in Table 5.

3.3.2. Study on effect of total cerium concentration on current efficiency in undivided cell

Electrochemical oxidation of cerium(III) methanesulphonate to cerium(IV) methanesulphonate was carried out in an

Table 5
Results of the electrochemical oxidation of Ce(III) to cerium(IV) in an undivided cell showing the influence of different anode current densities

| S. no. | Anode current density (mA/cm ²) | Cathode current density (mA/cm ²) | Time of electrolysis (min) | Cell voltage (V) | Current efficiency (%) |
|--------|---|---|----------------------------|------------------|------------------------|
| 1 | 5 | 40 | 140 | 3.8 | 88 |
| 2 | 10 | 80 | 70 | 5.8 | 91 |
| 3 | 15 | 120 | 46 | 7.0 | 86 |
| 4 | 20 | 160 | 35 | 8.5 | 86 |
| 5 | 25 | 200 | 28 | 10.5 | 79 |
| 6 | 30 | 240 | 23 | 10.5 | 83 |

Anode, DSA-O₂; cathode, stainless steel; electrolyte, cerium(III) methanesulphonate; stirring rate, 150 rpm; total cell capacity, 500 ml; type of cell, undivided batch cell; diaphragm, Nafion 324 series membrane; temperature, 50 °C.

undivided cell at a current density of 1 mA/cm² having different electrode area 1:8 (i.e. lower cathode area and higher anode area). Thus, 300 ml of 0.8 M cerium(III) in 2 M methanesulphonic acid was electrolysed to give maximum current efficiency of 88%. It is observed that the current efficiency for cerium(IV) formation increases with the increase in total cerium concentration (Table 10). This may be due to high mass transfer at higher cerium concentration.

3.3.3. Study on effect of methanesulphonic acid concentration on current efficiency in undivided cell

The effect of methanesulphonic acid concentration on current efficiency for cerium(IV) generation is illustrated using an electrolyte of 0.8 M total cerium concentration. The current efficiency for cerium(IV) generation increased from 50 to 91% when the free methanesulphonic acid concentration decreased from 5.5 to 0.5 M (Table 11). Increase in the current efficiency with decreasing acid concentration may be due to a decreased diffusion resistance as the solution viscosity decreases.

3.4. Process optimisation studies on process parameters for Ce(IV)/Ce(III) system

The following design parameters for the electrochemical generation of cerium(IV) methanesulphonate from cerium(III) methanesulphonate were investigated in a divided batch cell. The design parameters are current density, temperature, agitation and methanesulphonic acid concentration.

Table 6
Study on effect of current density on current efficiency

| S. no. | Current density (mA/cm ²) | Temperature (°C) | Cerium(III) (moles) | Cerium(IV) (moles) | Current efficiency (%) |
|--------|---------------------------------------|------------------|---------------------|--------------------|------------------------|
| 1 | 25 | 50 | 0.1053 | 0.0800 | 76 |
| 2 | 50 | 50 | 0.0891 | 0.0864 | 97 |
| 3 | 70 | 50 | 0.1037 | 0.0860 | 83 |
| 4 | 100 | 50 | 0.0912 | 0.0538 | 59 |
| 5 | 125 | 50 | 0.1027 | 0.0575 | 56 |
| 6 | 150 | 50 | 0.1048 | 0.0586 | 56 |

Anode, DSA-O₂; cathode, stainless steel; anolyte, cerium(III) methanesulphonate; catholyte, methanesulphonic acid; stirring rate, 150 rpm; total cell capacity, 500 ml; type of cell, divided batch cell; diaphragm, Nafion 324 series membrane; temperature, 50 °C.

For many optimisation projects in research, development and manufacturing, the sequential simplex design is the method of choice. It is very useful for optimisation studies. Experiments are successively performed in a direction of improvement until the optimum is reached. The simplex method can handle many variables with only a few trials, and does not require any assumptions with regard to the underlying model.

In an experiment, to change one or more process variables or factors in order to observe the effect the changes have on one or more response variables. The statistical design of experiment is an efficient procedure for planning experiments so that the data obtained can be analysed to yield valid and objective conclusions.

3.4.1. Effect of current density

Table 6 and Fig. 5 shows the effect of current density for Ce(IV)/Ce(III) system. The current efficiency for cerium(IV) ion generation is increased with increase in current density and decreased at an high current density, i.e. 150 mA/cm². At an optimum current density of 5 mA/cm², the current efficiency and yield were found to be 97 and 97%, respectively.

3.4.2. Effect of temperature

The mediated system reaction was carried out in the temperature range of 30–60 °C in a batch divided cell. Table 7 shows the effect of temperature for mediated electrochemical oxidation

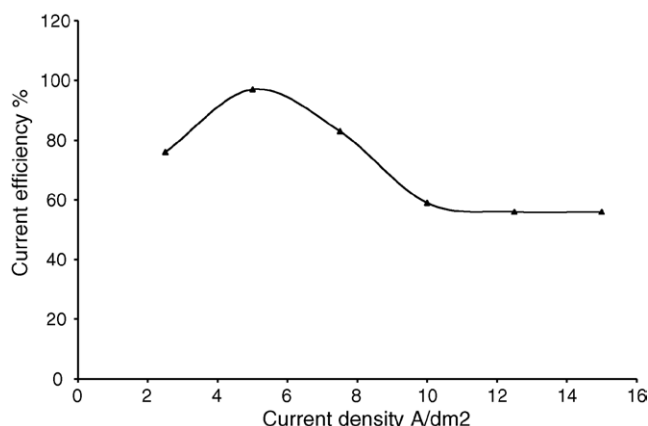

Fig. 5. Study on effect of current density.

Table 7
Study on effect of temperature on current efficiency

| S. no. | Temperature (°C) | Current density (mA/cm ²) | Cerium(III) (moles) | Cerium(IV) (moles) | Current efficiency (%) |
|--------|------------------|---------------------------------------|---------------------|--------------------|------------------------|
| 1 | 30 | 25 | 0.0904 | 0.0605 | 67 |
| 2 | 40 | 25 | 0.0912 | 0.0620 | 68 |
| 3 | 50 | 25 | 0.1053 | 0.0800 | 76 |
| 4 | 60 | 25 | 0.1031 | 0.0784 | 76 |
| 5 | 30 | 50 | 0.0674 | 0.0505 | 75 |
| 6 | 40 | 50 | 0.0671 | 0.0566 | 85 |
| 7 | 50 | 50 | 0.0679 | 0.0664 | 97 |
| 8 | 60 | 50 | 0.0681 | 0.0660 | 97 |
| 9 | 30 | 100 | 0.0930 | 0.0428 | 46 |
| 10 | 40 | 100 | 0.0980 | 0.0428 | 53 |
| 11 | 50 | 100 | 0.0912 | 0.0540 | 59 |
| 12 | 60 | 100 | 0.0951 | 0.0570 | 60 |

Anode, DSA-O₂; cathode, stainless steel; anolyte, cerium(III) methanesulphonate; catholyte, 2.0 M methanesulphonic acid; stirring rate, 150 rpm; total cell capacity, 500 ml; type of cell, divided batch cell; diaphragm, Nafion 324 series membrane; temperature, 30–60 °C.

Table 8
Study on effect of stirring rate on current efficiency

| S. no. | Stirring rate (rpm) | Cerium(III) (moles) | Cerium(IV) (moles) | Current efficiency (%) |
|--------|---------------------|---------------------|--------------------|------------------------|
| 1 | 60 | 0.1075 | 0.0641 | 60 |
| 2 | 80 | 0.1070 | 0.0670 | 63 |
| 3 | 100 | 0.1034 | 0.080 | 77 |
| 4 | 120 | 0.1038 | 0.090 | 87 |
| 5 | 140 | 0.1013 | 0.0982 | 97 |
| 6 | 160 | 0.1010 | 0.0971 | 97 |

Anode, DSA-O₂; cathode, stainless steel; anolyte, cerium(III) methanesulphonate; catholyte, methanesulphonic acid; stirring rate, 150 rpm; total cell capacity, 500 ml; type of cell, divided batch cell; diaphragm, Nafion 324 series membrane; temperature, 50 °C.

system. The current efficiency for cerium(IV) formation tends to increase with increase in temperature and it is given Fig. 6. The optimum temperature is 50 °C and this is ideal temperature for process development.

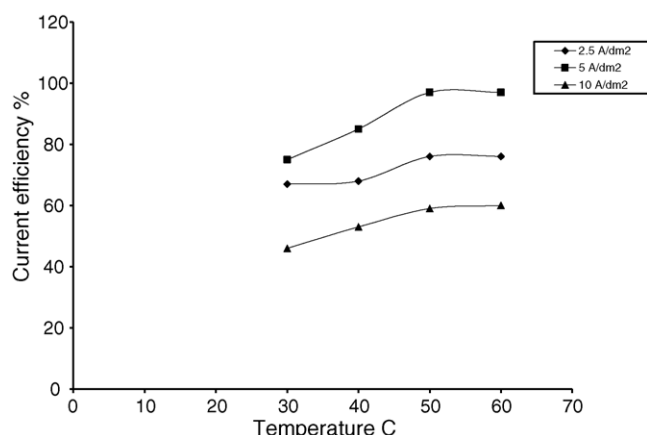

Fig. 6. Study on effect of temperature.

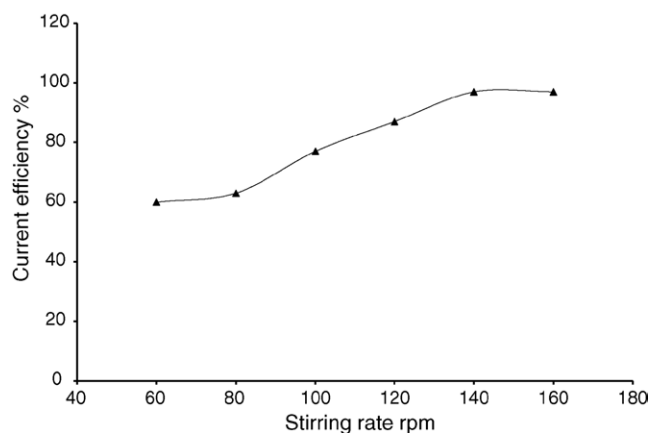

Fig. 7. Study on effect of stirring rate.

Table 9
Study on effect of cerium(III) methanesulphonate concentration on current efficiency

| S. no. | Cerium(III) methanesulphonate (M) | Anode | Cerium(III) (moles) | Cerium(IV) (moles) | Current efficiency (%) |
|--------|-----------------------------------|--------------------|---------------------|--------------------|------------------------|
| 1 | 0.6 | DSA-O ₂ | 0.1041 | 0.0864 | 83 |
| 2 | 0.8 | DSA-O ₂ | 0.1071 | 0.1043 | 97 |
| 3 | 1.0 | DSA-O ₂ | 0.1340 | 0.1160 | 89 |
| 4 | 0.6 | Platinum | 0.0991 | 0.0862 | 87 |
| 5 | 0.8 | Platinum | 0.0983 | 0.0952 | 97 |
| 6 | 1.0 | Platinum | 0.0982 | 0.0951 | 97 |

Anode, DSA-O₂; cathode, stainless steel; anolyte, cerium(III) methanesulphonate; catholyte, 2.0 M methanesulphonic acid; stirring rate, 150 rpm; total cell capacity, 500 ml; type of cell, divided batch cell; diaphragm, Nafion 324 series membrane; temperature, 50 °C.

3.4.3. Effect on agitation

The effect of stirring rate of electrolyte was carried out in the range of 75–150 rpm in the electrochemical batch cell. It was observed that the conversion is proceeding with increase of agitation. It was also seen that the mass transfer for the formation cerium(IV) is high in high agitation. The results are presented in Table 8 and Fig. 7.

Table 10
Studies on the effect of total cerium on the current efficiency in undivided cell

| S. no. | Cerium(III) methanesulphonate (M) | Ce(III) (moles) | Ce(IV) (moles) | Current efficiency (%) |
|--------|-----------------------------------|-----------------|----------------|------------------------|
| 1 | 0.5 | 0.1058 | 0.0670 | 63 |
| 2 | 0.6 | 0.1075 | 0.0770 | 72 |
| 3 | 0.7 | 0.1043 | 0.0870 | 83 |
| 4 | 0.8 | 0.1057 | 0.1025 | 95 |
| 5 | 0.9 | 0.1043 | 0.1011 | 97 |
| 6 | 1.0 | 0.1035 | 0.0980 | 95 |
| 7 | 1.2 | 0.1028 | 0.0980 | 95 |

Anode, DSA-O₂; cathode, stainless steel; anolyte, cerium(III) methanesulphonate; current density, 50 A/dm²; cell voltage, 4.5 V; stirrer speed, 150 rpm; diaphragm, Nafion 324 series cation membrane.

Table 11
Studies on the effect of methanesulphonic acid concentration on the current efficiency

| S. no. | Methanesulphonic acid concentration (M) | Ce(III) (moles) | Ce(IV) (moles) | Current efficiency (%) |
|--------|---|-----------------|----------------|------------------------|
| 1 | 0.5 | 0.1076 | 0.0753 | 70 |
| 2 | 1.0 | 0.1069 | 0.092 | 86 |
| 3 | 2.0 | 0.1065 | 0.1033 | 97 |
| 4 | 3.0 | 0.1062 | 0.088 | 83 |
| 5 | 4.0 | 0.1065 | 0.082 | 77 |
| 6 | 5.0 | 0.1063 | 0.068 | 64 |
| 7 | 5.5 | 0.1061 | 0.058 | 55 |

Anode, DSA-O₂; cathode, stainless steel; anolyte, cerium(III) methanesulphonate; catholyte, methanesulphonic acid; current density, 50 mA/cm²; cell voltage, 4.4 V; temperature, 50 °C; stirrer speed, 150 rpm; diaphragm, Nafion 324 series cation membrane.

3.4.4. Effect of anolyte concentration

The effect of cerium(III) methanesulphonate concentration was carried out from the range of 0.6–1.0 M solution. From the experiment, it was revealed that the current efficiency is increased with increase of cerium(III) concentration up to certain concentration and it was also seen that the cerium(IV) is precipitated in high concentration of, i.e. 3.0–4.0 M. The results are presented in Table 9.

4. Conclusion

For mediated electrochemical oxidation system, the following order of the cells are suitable and gives high current efficiency and low energy consumption:

- batch cell;
- batch re-circulation cell;
- flow cell electro MP cell.

In electrochemical cell, space–time yield is proportional to the applied current density, the proportionality being affected primarily by two factors current efficiency and specific electrode area. The result shows that good current efficiency and high space–time yield can be achieved for electrooxidation of Ce(III)/Ce(IV) system using the batch cell at an optimised process parameters.

The higher total cerium concentration in aqueous methanesulphonic acid makes the electrochemical generation of cerium(IV) in an undivided cell feasible. A high current efficiency for cerium(IV) generation at high anode current densities reduces the electrochemical cost, and subsequently the production cost of quinones. Capital and energy costs are kept low in an undivided cell. At lower values of acid concentration (0.5–4.0 M) and at higher total cerium concentration (0.8 M), the current efficiency for cerium(IV) concentration was (88–97%). However, further increase in the acid concentration does not favour the cerium(IV) ion generation.

Based on the above studies, optimum conditions for Ce(III)/Ce(IV) redox system were determined, which are as follows.

| | |
|------------------|---|
| Anode: | Dimensionally stable anode (DSA-O ₂) |
| Cathode: | Stainless steel |
| Diaphragm: | Cation exchange membrane – Nafion 324 |
| Anolyte: | Cerium(III) methanesulphonate(0.8 M) in methanesulphonic acid |
| Catholyte: | Methanesulphonic acid (2.0 M) |
| Current density: | 5 A/dm ² |
| Temperature: | 50 °C |
| Stirring rate: | 150 rpm |

References

- [1] N.L. Weinberg, B.V. Tilak (Eds.), *Technique of Electroorganic Synthesis, Part-3*, John Wiley and Sons, New York, 1982.
- [2] D. Pletcher, F.C. Walsh, *Industrial Electrochemistry*, second ed., Chapman and Hall, 1990.
- [3] R.E. White (Ed.), *Electrochemical Cell Design*, Plenum Press, New York, 1984.
- [4] F. Goodridge, in: U. Landau, E. Yeager, D. Kortan (Eds.), *Electrochemistry in Industry, New Directions*, Plenum Press, 1980.
- [5] D.E. Danly, *Emerging opportunities for Electro Organic Processes*, Marcel Dekker, 1984.
- [6] T.Z. Fahidy, *Principles of Electrochemical Reactor Analysis*, Elsevier, 1985.
- [7] L. Spyer, *Tetrahedron Lett.* 37 (1966) 4493.
- [8] T.L. Ho, *Synthesis* (1973) 347.
- [9] R.P. Kreh, R.M. Spotnitz, J.T. Lundquist, *Tetrahedron Lett.* 28 (1987) 1067.
- [10] D.J. Pickett, *Electrochemical Reactor Design*, Elsevier, New York, 1979, pp. 362–371.
- [11] R.P. Kreh, R.M. Spotnitz, J.T. Lundquist, *J. Org. Chem.* 54 (1989) 1526.
- [12] Periasamy, M.V. Bhatt, *Synthesis* (1977) 330.
- [13] Periasamy, M.V. Bhatt, *Tetrahedron Lett.* (1978) 4561.
- [14] K. Kramer, P.M. Robertson, N. Ibl, *J. Appl. Electrochem.* 10 (1980) 29–36.
- [15] R.M. Spotnitz, R.P. Kreh, J.T. Lundquist, *J. Appl. Electrochem.* 20 (1990) 209–215.
- [16] P. Pichaichanarong, R.M. Spotnitz, R.P. Kreh, S.M. Goldfrab, J.T. Lundquist, *AIChE Spring Meeting*, New Orleans, 1988.
- [17] I.M. Dalrymple, J.P. Millington, *J. Appl. Electrochem.* 16 (1986) 885–893.
- [18] C.H. Commminellis, E. Plattner, *J. Appl. Electrochem.* 13 (1983) 117–120.
- [19] F. Goodridge, K. Scott, *Electrochemical Process Engineering*, Plenum Press, New York, 1995, p. 14.
- [20] E. Heitz, G. Kreysa, *Principles of Electrochemical Engineering*, VCH, New York, 1986, p. 122.
- [21] F.L.S. Purgato, M.I.C. Ferreira, J.R. Romero, *J. Mol. Catal. A: Chem.* 161 (2000) 99–104.
- [22] A. Paulenova, S.E. Creager, J.D. Navratil, Y. Wei, *J. Power Sources* 109 (2002) 431.
- [23] Y. Liu, X. Xia, H. Liu, *J. Power sources* 130 (2004) 299–305.
- [24] S. Trasatti, in: H. Wendt (Ed.), *Electrochemical Hydrogen Technologies*, Elsevier, Amsterdam, 1990, p. 104.
- [25] S. Trasatti, A. Wieckowski (Eds.), *Interfacial Electrochemistry: Theory, Practice and Applications*, Marcel Dekker, New York, 1999, p. 769.
- [26] S. Trasatti (Ed.), *Electrodes of Conductive Metallic Oxides, Part A and Part B*, Elsevier, Amsterdam, 1980–1981.
- [27] S. Trasatti, *Electrochim. Acta* 45 (2000) 2377.
- [28] C. Angelinetta, S. Trasatti, Lj.D. Atanasoska, Z.S. Minevski, R.T. Atanasoski, *Mater. Chem. Phys.* 22 (1989) 231.
- [29] S. Trasatti, *Electrochim. Acta* 29 (11) (1984) 1503.
- [30] C.P. de Pauli, S. Trasatti, *J. Electroanal. Chem.* 538 (2002) 145.
- [31] A. Hrussanova, E. Guerrini, S. Trasatti, *J. Electroanal. Chem.* 564 (2004) 151.
- [32] Vogel's, *Text book of Quantitative Inorganic analysis*, fourth ed. Long Man, New York, 1978, p. 368.

- [33] T. Vijayarathi, D. Velayutham, M. Noel, *J. Appl. Electrochem.* 31 (2001) 976.
- [34] T. Vijayarathi, D. Velayutham, M. Noel, *Bull. Electrochem.* 18 (2002) 49.
- [35] V. Devadoss, M. Noel, C. Ahmed Basha, K. Jayaraman, *J. Appl. Electrochem.* 33 (2003) 319.
- [36] B. Fang, S. Iwasa, Y. Wei, T. Arai, M. Kumagai, *Electrochim. Acta* 47 (2002) 3971.
- [37] X. Xia, H. Liu, Y. Liu, *Acta Chim. Sin.* 60 (2002) 1630.
- [38] Y. Wei, B. Fang, T. Arai, M. Kumagai, *J. Appl. Electrochem.* 35 (2005) 561.